

GERMANA FLOODLIGHT

Rectangular floodlight with no visible screws made of shockproof resin material, UV-rays stabilized, rust and corrosion-free. Suitable for wall, ground and post installation. A fully adjustable bracket is available as option to direct the light emission. Supplied with TÜV approved, long-life and efficient **GX53 LED lamps included** or provided with **E27** lampholder. Motion sensor version available. Insulation class II, Protection rating IP66.



Proiettore rettangolare senza viti a vista, fabbricato in resina antiurto stabilizzata ai raggi UV, inattaccabile da ruggine e corrosione. Idoneo per installazioni a parete, al suolo e a palo. Il proiettore si può inclinare e orientare a piacimento con l'ausilio di un braccio opzionale. Provvisto di lampadine a LED GX53 approvate TÜV di lunga durata ed elevata efficienza o fornito nella versione E27. Disponibile anche con sensore di movimento. Classe di isolamento II, grado di protezione IP66.



2N1.000.C2L

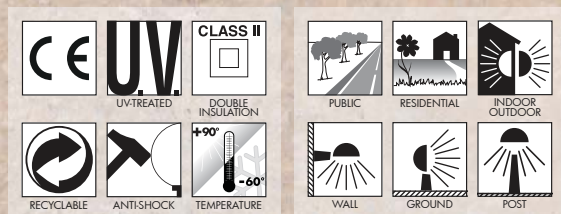

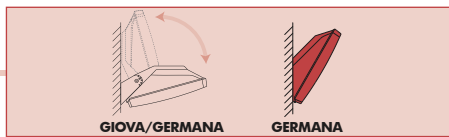

GERMANA - COMPONENTS

IP66



COVER with no visible screws, made of shockproof resin material, UV-rays stabilized.

COVER senza viti a vista in resina antiurto stabilizzata ai raggi UV.

DIFFUSER made of UV-rays stabilized polymethyl-methacrylate (PMMA) screwed to the floodlight body.

DIFFUSORE realizzato in polimetilmetacrilato (PMMA) stabilizzato ai raggi UV da avvitare al corpo del proiettore.

BODY made of shockproof resin material, UV-rays stabilized, provided with silicone rubber gasket to ensure high protection against external agents.

CORPO realizzato in resina antiurto, stabilizzata ai raggi UV, completa di guarnizione in gomma siliconica per garantire un alto livello di protezione contro gli agenti esterni.

GERMANA



Dimensions and weight

Height: 280 mm
Width: 180 mm
Weight: 0,45 Kg

Moulded Colours:

Black Grey White

Diffuser PC:

Opal Frosted (upon request)

2x GX53 LED



Version supplied **fully pre-wired** complete with TÜV approved, long-life and efficient **2x GX53 LED lamps included**. Different wattages available. Quick and easy lamp replacement for a very simple maintenance after installation.

*ADD. SUFFIX

	2x 3W 6W	700 Lm	4000 K .G2L
			3000 K .G2R
	2x 7W 14W	1600 Lm	4000 K .C2L
			3000 K .C2R
	2x 10W 20W	2400 Lm	4000 K .D2L
			3000 K .D2R

E27



Version supplied **fully pre-wired** with white resin reflective ceiling and complete with **E27 lampholder**. Daylight and motion sensor available as option. Sensor operating voltage: 220-240V. (120V version available on demand).

*ADD. SUFFIX

E27 (CFL-LED)	max 160 mm ↔	.P27
E27 + Sensor (CFL-LED)	max 160 mm ↔	.PS7

POST VERSION



Detailed information on next page.

* ADD THESE SUFFIXES TO THE REFERENCES MENTIONED IN THE CATALOGUE

LED LAMPS



More technical details about TÜV approved Fumagalli LED Lamps on page 468.

2x 10W = 50W
2.400 Lm SON-HQI

SAVE 60%

BULKHEAD
FLOODLIGHT
IN-GROUND
BRICKLIGHT
BOLLARDS
GARDEN
URBAN CLASSIC
URBAN MODERN
HIGH-BAY
POST
LAMPS



MADE IN
ITALY

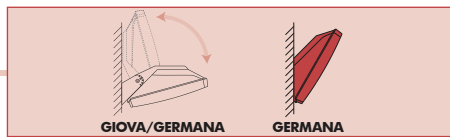

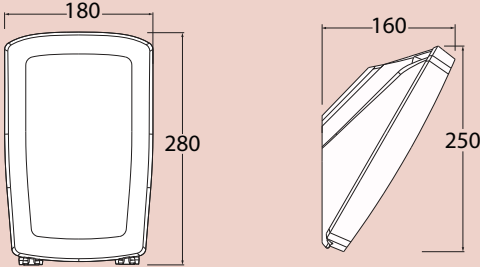
GERMANA		
2N1.000.G2L	6W	2N1.000.G2R
2N1.000.C2L	14W	2N1.000.C2R
2N1.000.D2L	20W	2N1.000.D2R
4000K	2x GX53 LED LAMP INCLUDED	3000K
		
Pcs 18 Kg 25 mc 0,198		
E27	2N1.000.P27	
E27 with sensor	2N1.000.PS7	

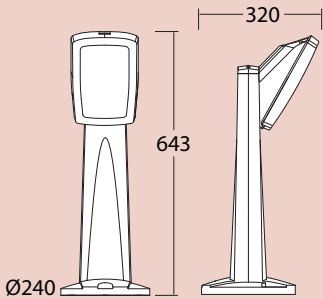
MINIPINELA 1L		
2N1.612.010.G2L	6W	2N1.612.010.G2R
2N1.612.010.C2L	14W	2N1.612.010.C2R
2N1.612.010.D2L	20W	2N1.612.010.D2R
4000K		3000K
		
Pcs 1 Kg 3,5 mc 0,06		
E27	2N1.612.010.P27	
E27 with sensor	2N1.612.010.PS7	

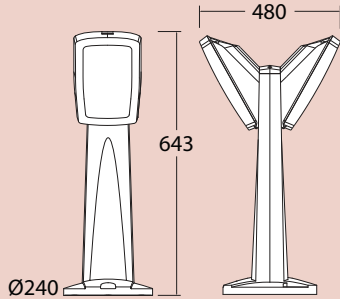
MINIPINELA 2L		
2N1.612.020.G2L	2x6W	2N1.612.020.G2R
2N1.612.020.C2L	2x14W	2N1.612.020.C2R
2N1.612.020.D2L	2x20W	2N1.612.020.D2R
4000K		3000K
		
Pcs 1 Kg 4 mc 0,06		
E27	2N1.612.020.P27	
E27 with sensor	2N1.612.020.PS7	

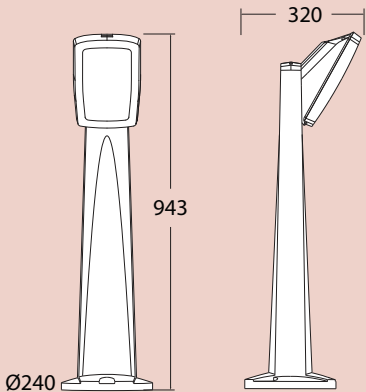
PINELA 1L		
2N1.613.010.C2L	6W	2N1.613.010.G2R
2N1.613.010.D2L	14W	2N1.613.010.C2R
2N1.613.010.D2L	20W	2N1.613.010.D2R
4000K		3000K
		
Pcs 1 Kg 4 mc 0,097		
E27	2N1.613.010.P27	
E27 with sensor	2N1.613.010.PS7	

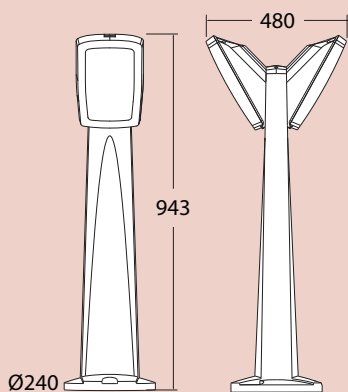
PINELA 2L		
2N1.613.020.C2L	2x6W	2N1.613.020.G2R
2N1.613.020.D2L	2x14W	2N1.613.020.C2R
2N1.613.020.D2L	2x20W	2N1.613.020.D2R
4000K		3000K
		
Pcs 1 Kg 5 mc 0,097		
E27	2N1.613.020.P27	
E27 with sensor	2N1.613.020.PS7	